

Fabrication of a knee-ankle-foot orthosis using thermoplastic technology

with CarbonIQ joint system

Technical information 5.4.6



Table of contents

1	Introduction	3
2	Materials and Products Used	3
3	Manufacturing Process	4
3.1	Mounting the Orthotic Joints	4
3.1.1	Assembling the System Knee Joints	4
3.1.2	Assembling the System Ankle Joints.....	5
3.2	Fabricating the Plaster Model	6
3.2.1	Fabricating the Plaster Negative	6
3.2.2	Fabricating the Plaster Positive.....	9
3.2.3	Modelling the Foot Area.....	10
3.2.4	Modelling the Leg Area.....	13
3.3	Preparing the Orthosis for Trial Fitting	14
3.3.1	Preparation for Vacuum Forming.....	14
3.3.2	Vacuum Forming	15
3.3.3	Preparing the Orthosis for Trial Fitting	16
3.3.4	Trial Fitting.....	20
3.4	Completion of the Orthosis	22
3.4.1	Adjusting the Orthosis	22
4	Appendices	26
4.1	Adaptation Options for the System Ankle Joints	26
4.2	Thermoplastic: Processing Instructions.....	27
4.3	Measurement Form	28

1 Introduction

This Technical Information is designed to support you as an orthotist when fabricating a lower extremity orthosis using the CarbonIQ Joint System, consisting of the 17PK1=* System Knee Joint and the 17PA1=* System Ankle Joint. The Technical Information explains all relevant steps from taking measurements on the user all the way to delivery of the completed orthosis.

This Technical Information addresses qualified professionals and assumes that these specialists are trained in the handling of different materials, machines and tools.

This Technical Information does not claim to be exhaustive.

The appendices to this Technical Information serve as leads only, and particularly the temperature data and processing guidelines for plastics are based on experience and can vary depending on climate and the condition of the oven.

2 Materials and Products Used

The materials and tools required are listed in the following tables. The tables list the materials and tools shown in the photos within this Technical Information. The prosthetist or orthotist assumes full responsibility when using any other materials.

Components and Devices	
Designation	Reference Number or Article Number
Knee joint	17PK1=*
Ankle joint	17PA1=*
Foot stirrup	17PF1
System bar material	605P8=*
Small parts: screws, rivets, locking nuts, etc.	

Materials	
Designation	Reference Number or Article Number
Thermoplastic	see Page 27
Terry Cloth padding fabric	623P3
Space-Tex	623F62
Micro-Velcro	623Z4=50-6

Tools	
Designation	Reference Number or Article Number
Knee pivot gauge	743A8
Foot casting aid	743A9
Pivot point adjustment aid	743A7
Orthotic joint alignment fixture	743R6

Machines, Equipment and Accessories	
Designation	Reference Number or Article Number
L.A.S.A.R. Posture	743L100

3 Manufacturing Process

3.1 Mounting the Orthotic Joints

3.1.1 Assembling the System Knee Joints

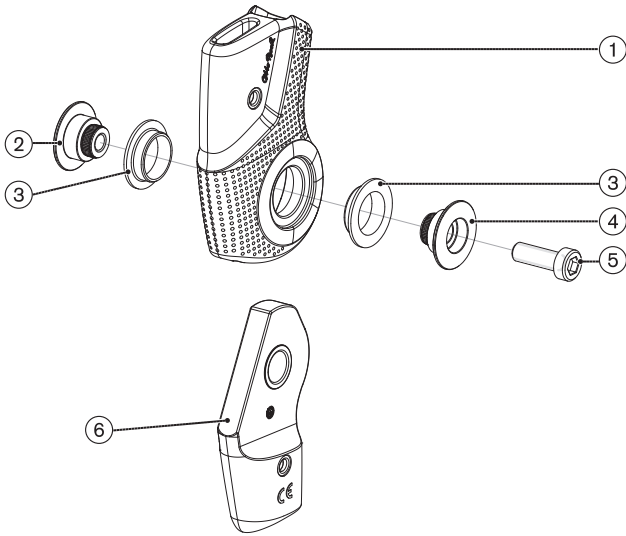

Insert the bearing bushings (3) into the upper joint section (1).

Slide the lower joint section (6) into the upper joint section (1) and secure it with the joint bolt (4), the joint nut with internal thread (2) and the cap screw (5).

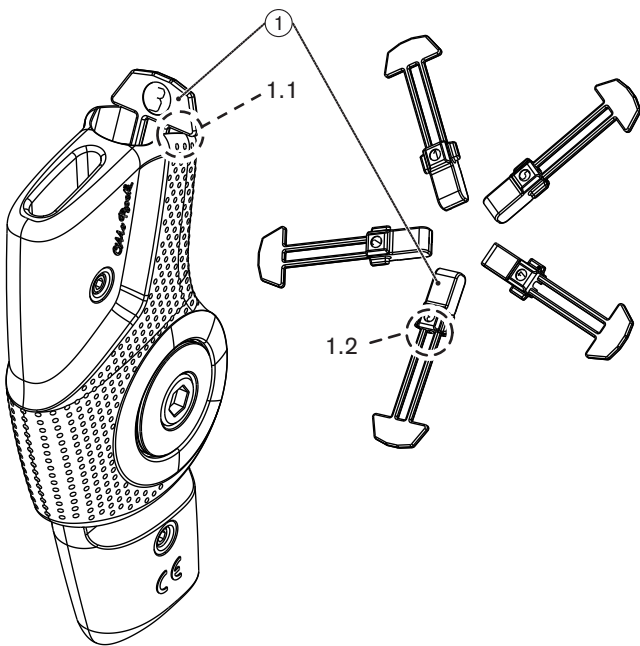

Introduce the lock (1 - size 3) into the lock channel until the insertion limiter of the lock (1.1) is up against the orthotic knee joint.

If the lock cannot be introduced into the lock channel up to the insertion limiter, a smaller lock (size 1 or 2) must be selected. If the lock has excessive play in the lock channel, a larger lock (size 4 or 5) must be selected.

Break off the suitable lock at position 1.2 of the inlet guide.



Screw the threaded sleeve onto the pull-release cable. Insert the pull-release cable with threaded sleeve into the chosen lock.

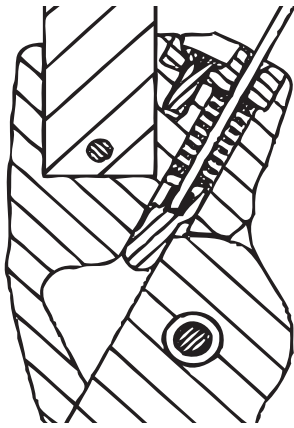

Guide the pull-release cable through the compression spring and lock cover.

Insert the lock and the compression spring with the pull-release cable into the lock channel.

Use the countersunk head screw to fasten the lock cover in the upper joint section.

Assemble the second system knee joint in the same way.

3.1.2 Assembling the System Ankle Joints

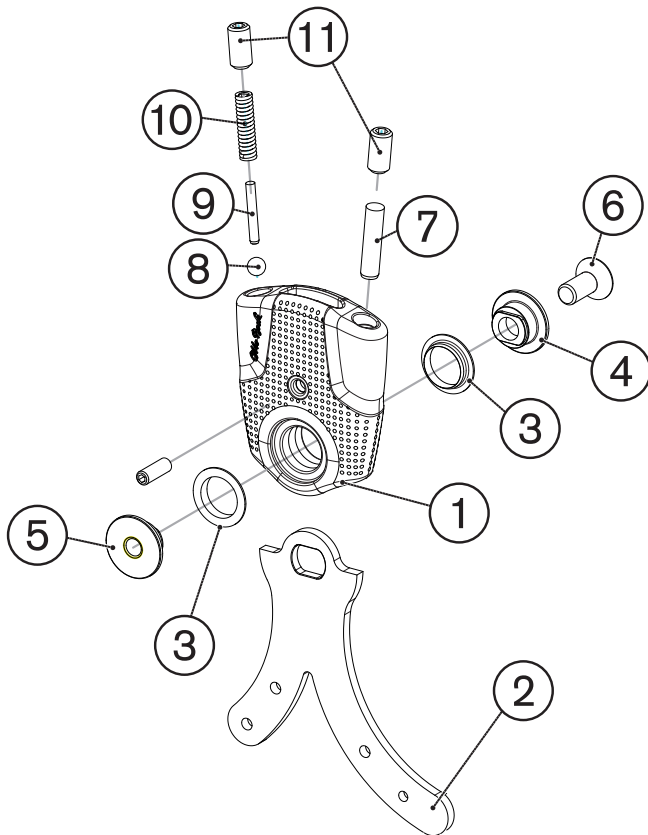

Following the guidelines in the chapter headed "Adaptation Options for the System Ankle Joints" (see Page 26), select a suitable combination for mounting the cylindrical pins (7, 9), pressure springs (10) and balls (8) to meet the needs of the user.

Tighten the setscrews (11).

Mount the system ankle joints (1) to the foot stirrups (2). Slide the bearing bushings (3) onto the system ankle joint (1).

Secure the foot stirrup (2) with the joint bolt (4), the joint nut with internal thread (5) and the cap screw (6).

Assemble the second system ankle joint in the same way.

3.2 Fabricating the Plaster Model

3.2.1 Fabricating the Plaster Negative



Apply the markings to the user and enter at least the following user measurements on the measurement form (see Page 28) (observe the bony structures while doing so!):

Distance from knee-joint gap to floor



Knee joint width (average between flexed and extended condition!)



Distance from ankle-joint centre of rotation to floor

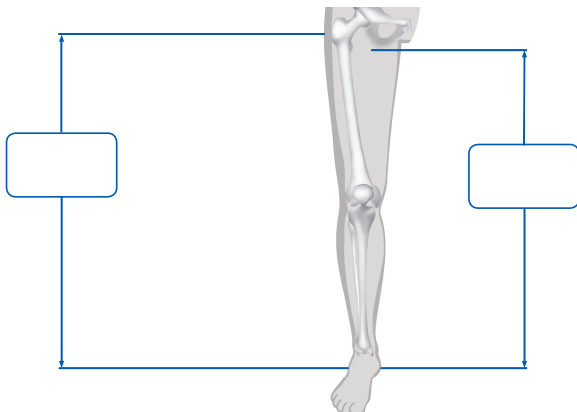

Maximum overall medial and lateral height



Width of ankle joint
Width of forefoot under load



Determine the heel height resp. the compensation and the toe pitch, and then adapt the foot casting aid accordingly.
Apply plaster insulation cream to the foot.



Prepare the plaster negative for the foot.
After setting, remove the plaster negative of the foot from the foot.
If necessary, correct the plaster negative of the foot.



Pull a stockinette up over the max. height of the orthosis.
To protect the plaster negative when it is to be cut open, insert corresponding protection into the stockinette from the tip of the foot to above the max. height.
Apply the plaster negative foot to the foot.



Position the lower leg on the foot casting aid at an angle of 90° to the foot.



Continue applying the plaster cast in the area of the foot and lower leg (up to a maximum of 10 cm below the knee joint).



Depending on the constitution of the user, place him/her on an examination table or seat him/her on the edge of the examination table. Move the knee joint into the position defined by the orthosis and then continue with the plaster cast.



If there are any deviations in the knee joint, e.g. valgus/varus deviations, make adjustments by hand.



Hold the knee joint in the adjusted position and wait until the plaster has set.



Mark the cutting line on the plaster.
Carefully cut open the plaster negative.
Remove the plaster negative.

3.2.2 Fabricating the Plaster Positive



Clamp the plaster negative into the alignment apparatus.
Using the measurements made, precisely determine the pivot points of the system joints.

Open the plaster negative at the pivot points of the system joints and incorporate the parallel retainers for the system knee joint and system ankle joint (ensure that the parallel retainers do not get bent!).

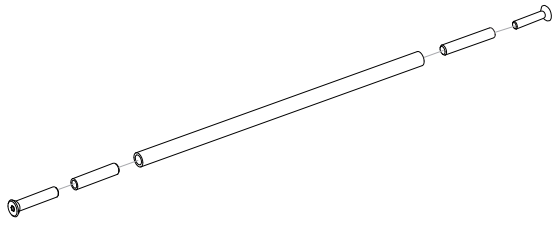

Insert a metal rod into the plaster negative.
Close and extend the plaster negative.
Pour plaster into the plaster negative and allow to set.

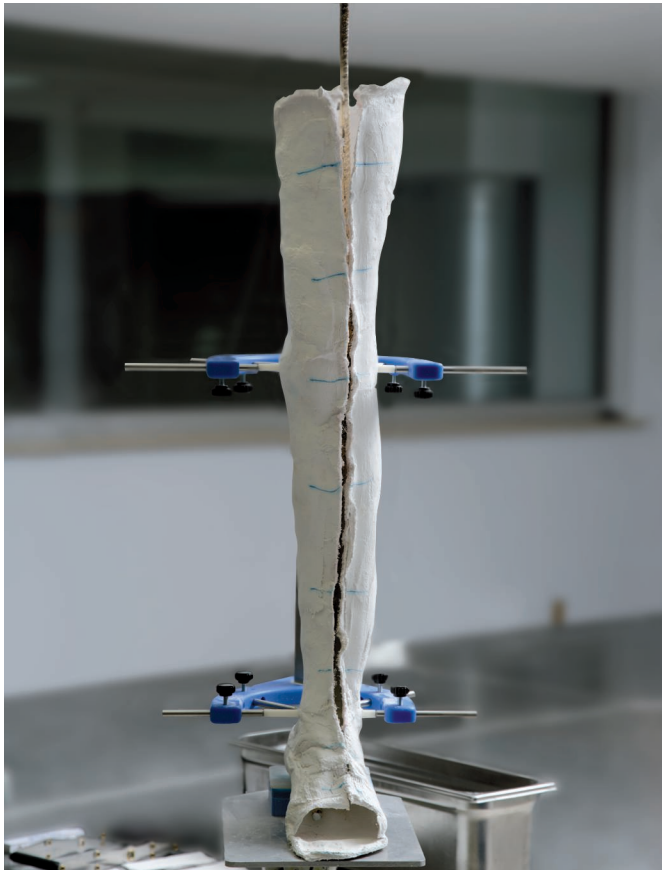

3.2.3 Modelling the Foot Area

After the plaster negative has set, remove it from the plaster positive.
Shorten the parallel retainers.





In the joint area, adjust the width to the measurements that were made.



Attach the joints to see that they fit.

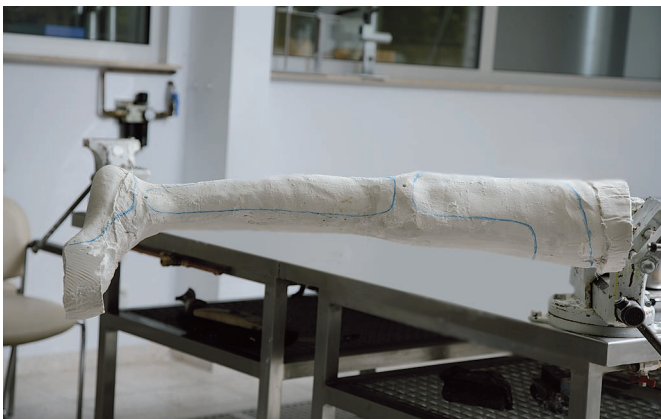

Design the orthosis according to the specifications determined from the anamnesis and mark correspondingly on the plaster positive.



Shape the heel and forefoot area of the sole parallel to each other.



Shape the heel and achilles tendon.



Include a calcaneus brace if desired.



Incorporate the longitudinal arch and midfoot support.



Check the width of the ankle joint compared with the measured value on the measurement form.



Mark and mould the flexion cut-out.

3.2.4 Modelling the Leg Area



Shape the edges of the shells.



Smooth the surface.



Check the alignment:

- e.g. correct any valgus/varus deviations
- Position of the knee joint in AP
- Foot position
- Dimensions

3.3 Preparing the Orthosis for Trial Fitting

3.3.1 Preparation for Vacuum Forming



Pull a Pedilin pad over the foot area of the plaster positive.



Bend the foot stirrups to match the foot contour.

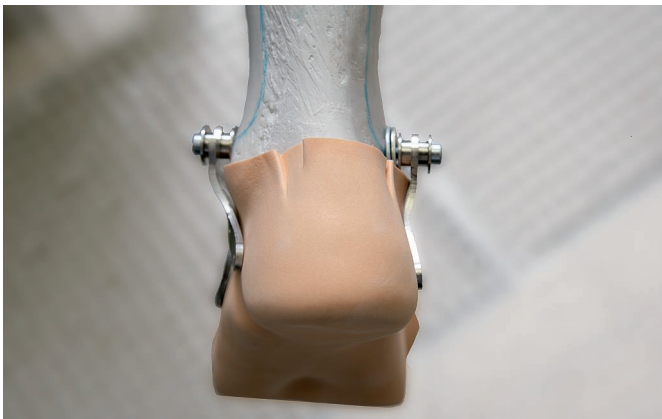

Screw-fasten the foot stirrups on both sides of the parallel retainer using the joint bushing and the cap screw (see Page 5, Chapter "Assembling the System Ankle Joints" exploded view diagram items 4, 5 and 6). If required, use spacer washers to increase the gap at the ankle joint.

Check the shape of the foot stirrups and adjust if necessary.



Remove the foot stirrups from the plaster positive. Clamp the plaster positive into the vice.

Pull a Perlon stockinette over the plaster positive.



If necessary, apply a height compensator up to 3 cm. The height compensator can be attached either to the inside or the outside of the orthosis foot piece. In accordance with the gap for the padding, pull additional Perlon stockinettes over the plaster positive.



Use a knife to cut holes into the Perlon stockinettes in the area of the parallel retainers.

3.3.2 Vacuum Forming



Preheat the oven.

Cut the thermoplastic material in such a way to allow sufficient coverage during vacuum forming.

Place the thermoplastic material into the oven (for processing temperatures see Chapter "Thermoplastic: Processing Instructions" - see Page 27).

Place the foot stirrup into the oven during the last 3 minutes.

Remove the foot stirrup from the oven, mount it on the plaster positive and secure it with a nail (see photo).



If optional Thermoprepreg strips (1) are to be used to provide additional reinforcement, heat the strips together with the thermoplastic material (same temperature and same duration) and place them on the model just prior to vacuum forming.

Remove the thermoplastic material from the oven and vacuum form it over the plaster positive.



Close the thermoplastic material proximally.
Switch on the suction unit to create the vacuum.



Use an arbor tool to press markings for the threaded boreholes of the foot stirrups into the thermoplastic material.



Shorten and press the overlapping thermoplastic material to form an even rim.
Allow the thermoplastic material to cool down.

3.3.3 Preparing the Orthosis for Trial Fitting



Using the markings in the area of the foot stirrups' boreholes, bore holes (Ø 3.2 mm) into the thermoplastic material.

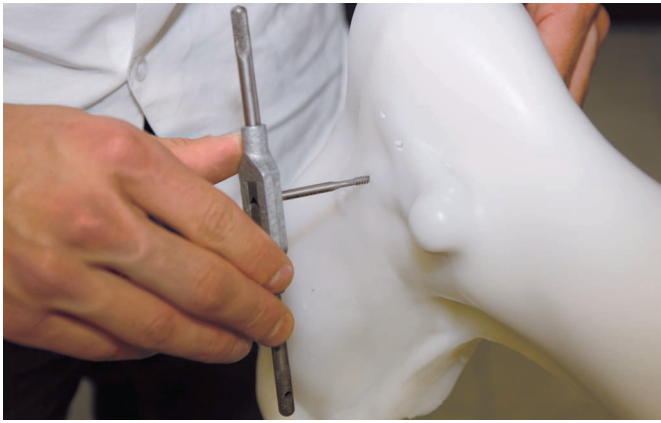

Cut threads (\varnothing 4 mm) into the foot stirrups' boreholes.



Use M4 countersunk head screws to fasten the foot stirrups to the foot cups.
Mark the upper edge of the foot piece and the lower edge of the lower leg shell.



Cut open along the marking (make sure not to damage the foot stirrups), remove from the form and deflash.



Uncover the joint head of the foot stirrup.



Also apply a mark for uncovering the parallel retainer on the knee joint, cut it open and then deflash.



Apply the system knee joints to the trial orthosis. Provisionally apply the system bars.



Set the system bars for the upper and lower leg areas corresponding to the orthosis.
Cut to length the system bars for the lower leg area providing an excess length of 5 – 10 cm.



After setting, determine the final length of the system bar on the ankle joint and then adapt the system bar accordingly.

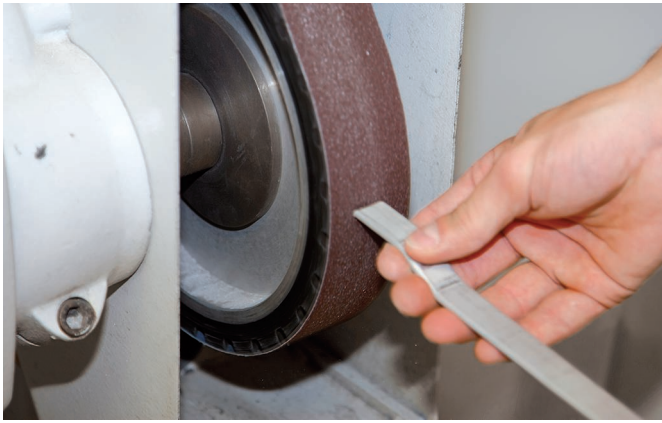

Rework the fit of the system bars and remove any ridges and burrs.



Check the positioning of the system bars for the lower leg, making sure that the system ankle joints are seated parallel within the stop.

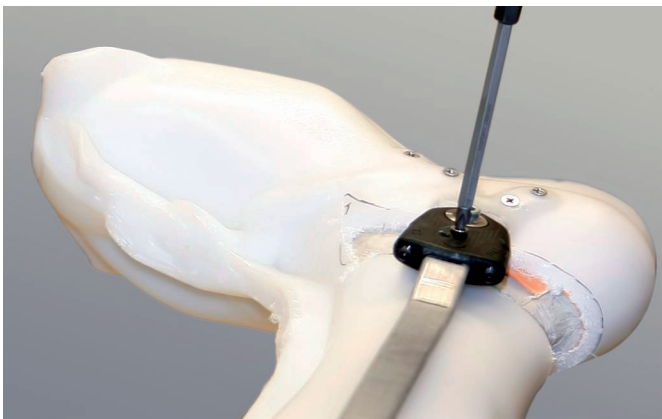

Insert the system bar into the system bar receiver and mark the borehole on the system bar.
Remove the system bar from the system bar receiver and drill a \varnothing 4 mm borehole into the system bar.
Use the set screw to screw together the system bar and the system knee joint.
The set screw is self-tapping and cuts a corresponding thread into the knee and ankle joints.



Mark, bore and cut to length the system bars for the thigh and screw-fasten them to the system knee joints.



Check the overall positioning of the system joints and the system bars.

Bore the holes (\varnothing 4 mm) for fixating the system bars and secure with screws (commence close to the joint).



Cut open the foot piece and the orthosis bushings, remove from the plaster model and finish (grind and deburr).

Remove the orthosis from the plaster positive.

Use countersunk screws and locking nuts to screw-fasten the provisional assembly of the system joints, bars, orthosis bushings and the foot piece.

Attach the orthosis to the plaster positive and check the alignment.

3.3.4 Trial Fitting



Perform the first trial fitting on the user.

During the first trial fitting, use circularly applied Velcro closures or straps.

Do not permanently fasten the orthosis as yet, because changes in position can still be made.



Check the fit, safety and function of the alignment.



If available, use a L.A.S.A.R. Posture for determining the alignment.



Perform a standing and walking trial with the user.

3.4 Completion of the Orthosis

3.4.1 Adjusting the Orthosis

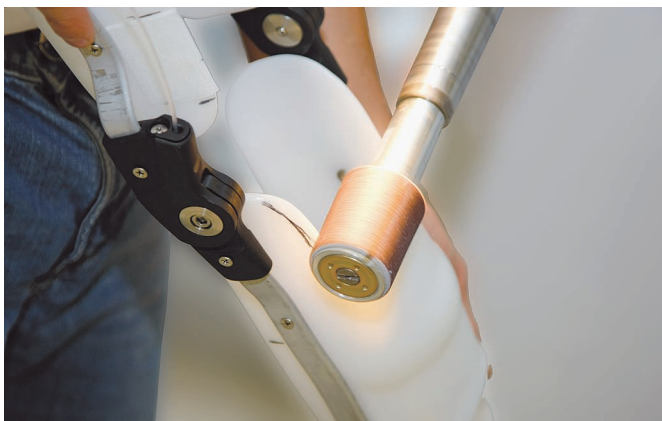

Only after all fitting and/or alignment problems have been resolved can the orthosis be completed.



Attach the closures in the desired position.

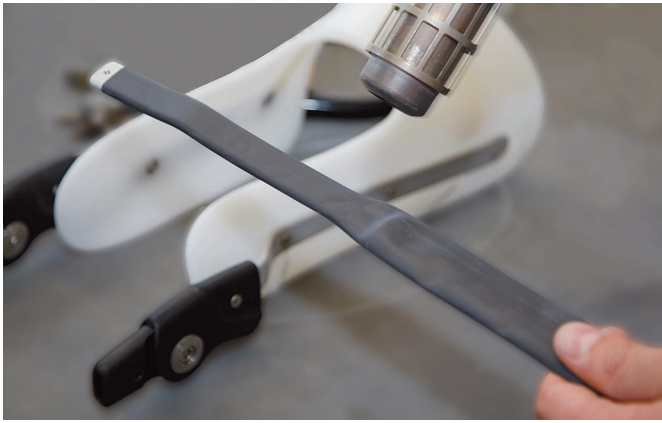

Cover the system bars with black shrink tubing and heat.

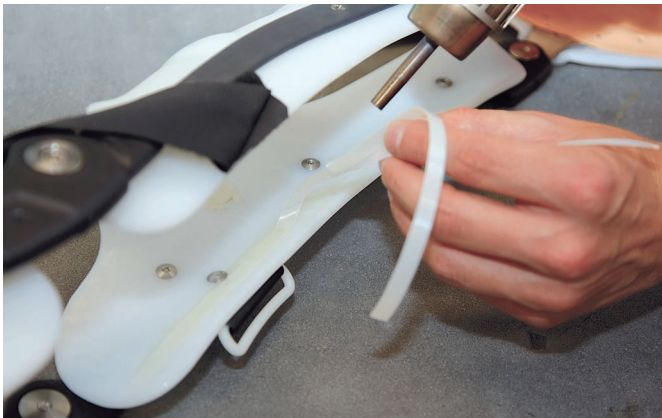

Bond micro-Velcro or similar material into the orthosis for fastening the pads.

Note: To provide a better bonding, first lightly apply contact adhesive to the plastic and slightly heat the adhesive surfaces of the Velcro.



Secure the joint bolts and the joint nuts with 636K13 Loctite® 241.



For stability reasons, the system bars must be bonded into the system bar receivers of the system joints using 636W28 Ottobock Special Adhesive.

Use 634A1 Ottobock thinner and solvent to degrease the bonding surfaces of the system bars and system bar receivers.

Thoroughly mix the contents of the two tubes (special adhesive and hardener 1:1) and apply the mixture to the components being bonded.

Insert the system bars and secure them with the set screws. The final bonding strength of the adhesive is reached after 16 h.



If necessary, shorten the pull-release cable of the lock and reinsert it into the lock.



Install the padding.



Before delivering to the user, check the completed orthosis as follows:

- Closures properly fastened?
- Joints and bars screw-fastened and secured?
- Padding installed?
- Mounting screws shortened and secured?
- Function checked?



Conduct a final functional test with the user:
(walking, standing, sitting, getting up, other movements)



If a L.A.S.A.R. Posture is available, use it and document the final result.

Delivery of the finished orthosis.

4 Appendices

4.1 Adaptation Options for the System Ankle Joints

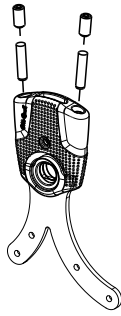
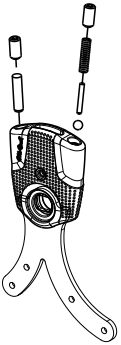
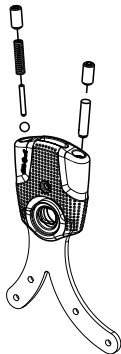
During assembly, the system ankle joints can be adapted to the needs of the user as follows:

	Installation position and effect	Application
	<p>Anterior and posterior: stop pin</p> <ul style="list-style-type: none"> • Limitation of movement • Adjustable fixed positioning 	<p>e.g. ICP or spina bifida</p>
	<p>Anterior: spring stop</p> <ul style="list-style-type: none"> • Support for plantar flexion • Damping and limitation of dorsal extension <p>Posterior: stop pin</p> <ul style="list-style-type: none"> • Limitation of plantar flexion 	<p>Indication similar to 2., but with additionally adjustable damped dorsal stop</p>
	<p>Anterior: stop pin</p> <ul style="list-style-type: none"> • Limitation of dorsal extension <p>Posterior: spring stop</p> <ul style="list-style-type: none"> • Support of dorsal extension • Damping and limitation of plantar flexion 	<p>Dorsiflexion assist, e.g. in case of pareses of the lower leg muscles without muscular knee joint protection</p>
	<p>Anterior and posterior: spring stop</p> <ul style="list-style-type: none"> • Dorsal and plantar support for knee joint protection • Damping and limitation of plantar flexion and dorsal flexion, for restricted range of motion 	<p>e.g. in case of pareses in the lower leg muscles with weakness of the knee-protecting muscles</p>

4.2 Thermoplastic: Processing Instructions

Product designations (Material)	Areas of application:							Processing temperatures (in °C)		
	FO	DAFO	AFO	Positioning orthosis	Test KAFO	KAFO	Orthosis strap	Heating plate	Convec- tion oven	Infrared heating cabinet
ThermoLyn® Trolen 616T3 (PE-LD)						•	•	125		
ThermoLyn® PP Copolymer 616T120 (PP-C)		•	•	•		•		215	185	
ThermoLyn® PP Homopolymer 616T20 (PP-H)	•	•	•			•		215	185	
ThermoLyn® Poly- ethylene 200 616T19, 616T58, 616T60, 616T61, 616T95 (PE-HD 200)				•		•		180	165	
ThermoLyn® RCH 500 616T22, 616T43, 616T44 (PE-HD 500)				•		•		195	185	
ThermoLyn® RCH 1000 616T16 (PE-HD 1000)	•							215	195	
ThermoLyn® clear 616T83 (Copolyester)					•			165		
ThermoLyn® Europlex 616T70 (Polyamide)	•							–	135	
ThermoLyn® PP-C SilverShield® 616T220, 616T221, 616T222 (Predefined sheet size - ready to use) (PP-C)			•					–	185	

SilverShield® is a registered trademark of North Sea Plastics.

4.3 Measurement Form

Date

Orthotist/Therapist

Name of the user

ID

Device number

Order number

Left

Height measurements not including heel height

Right

Height measurements including heel height

Measurement reference point

Gap between tibia and femur

Knee rotation point

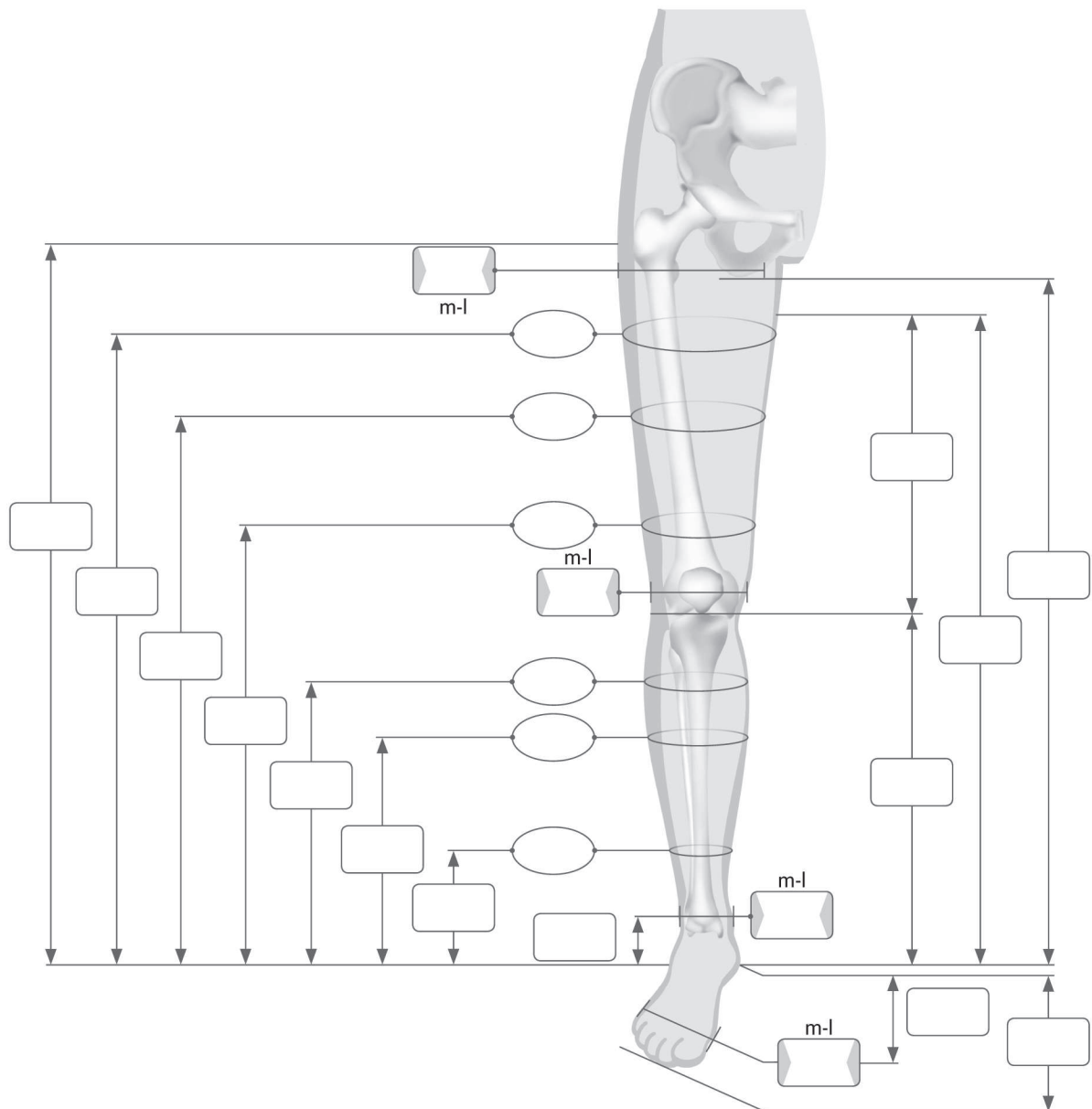

Kundenservice/Customer Service

Europe

Otto Bock HealthCare Deutschland GmbH
Max-Näder-Str. 15 · 37115 Duderstadt · Germany
T +49 5527 848-3455 · F +49 5527 848-1510
healthcare@ottobock.de · www.ottobock.de

Otto Bock Healthcare Products GmbH
Brehmstraße 16 · 1110 Wien · Austria
F +43 1 5267985
service-admin.vienna@ottobock.com · www.ottobock.at

Otto Bock Adria d.o.o. Sarajevo
Ramiza Salčina 85
71000 Sarajevo · Bosnia-Herzegovina
T +387 33 255-405 · F +387 33 255-401
obadria@bih.net.ba · www.ottobockadria.com.ba

Otto Bock Bulgaria Ltd.
41 Tzar Boris III Blvd. · 1612 Sofia · Bulgaria
T +359 2 80 57 980 · F +359 2 80 57 982
info@ottobock.bg · www.ottobock.bg

Otto Bock Suisse AG
Luzerner Kantonsspital 10 · 6000 Luzern 16 · Suisse
T +41 41 455 61 71 · F +41 41 455 61 70
suisse@ottobock.com · www.ottobock.ch

Otto Bock ČR s.r.o.
Protetická 460 · 33008 Zruč-Senec · Czech Republic
T +420 377825044 · F +420 377825036
email@ottobock.cz · www.ottobock.cz

Otto Bock Iberica S.A.
C/Majada, 1 · 28760 Tres Cantos (Madrid) · Spain
T +34 91 8063000 · F +34 91 8060415
info@ottobock.es · www.ottobock.es

Otto Bock France SNC
4 rue de la Réunion · CS 90011
91978 Courtaboeuf Cedex · France
T +33 1 69188830 · F +33 1 69071802
information@ottobock.fr · www.ottobock.fr

Otto Bock Healthcare plc
32, Parsonage Road · Englefield Green
Egham, Surrey TW20 0LD · United Kingdom
T +44 1784 744900 · F +44 1784 744901
bockuk@ottobock.com · www.ottobock.co.uk

Otto Bock Hungária Kft.
Tatai út 74. · 1135 Budapest · Hungary
T +36 1 4511020 · F +36 1 4511021
info@ottobock.hu · www.ottobock.hu

Otto Bock Adria d.o.o.
Dr. Franje Tuđmana 14 · 10431 Sveta Nedelja · Croatia
T +385 1 3361 544 · F +385 1 3365 986
ottobockadria@ottobock.hr · www.ottobock.hr

Otto Bock Italia Srl Us
Via Filippo Turati 5/7 · 40054 Budrio (BO) · Italy
T +39 051 692-4711 · F +39 051 692-4720
info.italia@ottobock.com · www.ottobock.it

Otto Bock Benelux B.V.
Mandenmaker 14 · 5253 RC
Nieuwkuijk · The Netherlands
T +31 73 5186488 · F +31 73 5114960
info.benelux@ottobock.com · www.ottobock.nl

Industria Ortopédica Otto Bock Unip. Lda.
Av. Miguel Bombarda, 21 - 2º Esq.
1050-161 Lisboa · Portugal
T +351 21 3535587 · F +351 21 3535590
ottobockportugal@mail.telepac.pt

Otto Bock Polska Sp. z o. o.
Ulica Korolowa 3 · 61-029 Poznań · Poland
T +48 61 6538250 · F +48 61 6538031
ottobock@ottobock.pl · www.ottobock.pl

Otto Bock Romania srl
Șos de Centura Chitila - Mogoșoaia Nr. 3
077405 Chitila, Jud. Ilfov · Romania
T +40 21 4363110 · F +40 21 4363023
info@ottobock.ro · www.ottobock.ro

OOO Otto Bock Service
p/o Pultikovo, Business Park „Greenwood”,
Building 7, 69 km MKAD
143441 Moscow Region/Krasnogorskiy Rayon
Russian Federation
T +7 495 564 8360 · F +7 495 564 8363
info@ottobock.ru · www.ottobock.ru

Otto Bock Scandinavia AB
Koppargatan 3 · Box 623 · 60114 Norrköping · Sweden
T +46 11 280600 · F +46 11 312005
info@ottobock.se · www.ottobock.se

Otto Bock Slovakia s.r.o.
Röntgenova 26 · 851 01 Bratislava 5 · Slovak Republic
T +421 2 32 78 20 70 · F +421 2 32 78 20 89
info@ottobock.sk · www.ottobock.sk

Otto Bock Sava d.o.o.
Industrijska bb · 34000 Kragujevac · Republika Srbija
T +381 34 351 671 · F +381 34 351 671
info@ottobock.rs · www.ottobock.rs

Otto Bock Ortopedi ve
Rehabilitasyon Tekniği Ltd. Şti.
Mecidiyeköy Mah. Lati Lokum Sok.
Meriç Sitesi B Blok No: 30/B
34387 Mecidiyeköy-Istanbul · Turkey
T +90 212 3565040 · F +90 212 3566688
info@ottobock.com.tr · www.ottobock.com.tr

Africa

Otto Bock Algérie E.U.R.L.
32, rue Ahcène Outaleb - Coopérative les Mimosas
Mackle-Ben Aknoun · Alger · DZ Algérie
T +213 21 913863 · F +213 21 913863
information@ottobock.fr · www.ottobock.fr

Otto Bock Egypt S.A.E.
28 Soliman Abaza St. Mohandessein · Giza · Egypt
T +20 2 37606818 · F +20 2 37605734
info@ottobock.com.eg · www.ottobock.com.eg

Otto Bock South Africa (Pty) Ltd
Building 3 Thornhill Office Park · 94 Bekker Road
Midrand · Johannesburg · South Africa
T +27 11 564 9360
info-southafrica@ottobock.co.za
www.ottobock.co.za

Americas

Otto Bock Argentina S.A.
Av. Belgrano 1477 · CP 1093
Ciudad Autónoma de Buenos Aires · Argentina
T +54 11 5032-8201 / 5032-8202
atencionclientes@ottobock.com.ar
www.ottobock.com.ar

Otto Bock do Brasil Tecnica Ortopédica Ltda.
Alameda Maria Tereza, 4036, Bairro Dois Córregos
CEP: 13.278-181, Valinhos-São Paulo · Brasil
T +55 19 3729 3500 · F +55 19 3269 6061
ottobock@ottobock.com.br · www.ottobock.com.br

Otto Bock HealthCare Canada
5470 Harvester Road
Burlington, Ontario, L7L 5N5, Canada
T +1 800 665 3327 · F +1 800 463 3659
CACustomerService@ottobock.com ·
www.ottobock.ca

Oficina Ottobock Habana
Calle 3ra entre 78 y 80.
Edificio Jerusalem · Oficina 112 · Calle 3ra.
Playa, La Habana. Cuba
T +53 720 430 69 · +53 720 430 81
hector.corcho@ottobock.com.br
www.ottobock.com.br

Otto Bock HealthCare Andina Ltda.
Calle 138 No 53-38 · Bogotá · Colombia
T +57 1 8619988 · F +57 1 8619977
info@ottobock.com.co · www.ottobock.com.co

Otto Bock de Mexico S.A. de C.V.
Prolongación Calle 18 No. 178-A
Col. San Pedro de los Pinos
C.P. 01180 México, D.F. · Mexico
T +52 55 5575 0290 · F +52 55 5575 0234
info@ottobock.com.mx · www.ottobock.com.mx

Otto Bock HealthCare LP
11501 Alterra Parkway Suite 600
Austin, TX 78758 · USA
T +1 800 328 4058 · F +1 800 962 2549
USCustomerService@ottobock.com
www.ottobockus.com

Asia/Pacific

Otto Bock Australia Pty. Ltd.
Suite 1.01, Century Corporate Centre
62 Norwest Boulevard
Baulkham Hills NSW 2153 · Australia
T +61 2 8818 2800 · F +61 2 8814 4500
healthcare@ottobock.com.au · www.ottobock.com.au

Beijing Otto Bock Orthopaedic Industries Co., Ltd.
B12E, Universal Business Park
10 Jiuxianqiao Road, Chao Yang District
Beijing, 100015, P.R. China
T +8610 8598 6880 · F +8610 8598 0040
news-service@ottobock.com.cn
www.ottobock.com.cn

Otto Bock Asia Pacific Ltd.
Unit 1004, 10/F, Greenfield Tower, Concordia Plaza
1 Science Museum Road, Tsim Sha Tsui
Kowloon, Hong Kong · China
T +852 2598 9772 · F +852 2598 7886
info@ottobock.com.hk · www.ottobock.com

Otto Bock HealthCare India Pvt. Ltd.
20th Floor, Express Towers
Nariman Point, Mumbai 400 021 · India
T +91 22 2274 5500 / 5501 / 5502
information@indiaottobock.com · www.ottobock.in

Otto Bock Japan K. K.
Yokogawa Building 8F, 4-4-44 Shibaura
Minato-ku, Tokyo, 108-0023 · Japan
T +81 3 3798-2111 · F +81 3 3798-2112
ottobock@ottobock.co.jp · www.ottobock.co.jp

Otto Bock Korea HealthCare Inc.
4F Agaworld Building · 1357-74, Seocho-dong
Seocho-ku, 137-070 Seoul · Korea
T +82 2 577-3831 · F +82 2 577-3828
info@ottobockkorea.com · www.ottobockkorea.com

Otto Bock South East Asia Co., Ltd.
1741 Phaholyothin Road
Kwaeng Chatuchark · Khet Chatuchark
Bangkok 10900 · Thailand
T +66 2 930 3030 · F +66 2 930 3311
obsea@ottobock.co.th · www.ottobock.co.th



Printed by:

Otto Bock HealthCare GmbH
Max-Näder-Straße 15 · 37115 Duderstadt · Germany
T +49 5527 848-0 · F +49 5527 72330
healthcare@ottobock.de · www.ottobock.com