

S. Blumentritt, E. Ludwigs, M. Bellmann, H. Boiten

The New Helix^{3D} Hip Joint

The New Helix^{3D} Hip Joint

The concept of a new exoprosthesis hip joint – the Helix^{3D} Hip Joint – is described. First results and experience gained by biomechanical gait analysis studies as well as trial fittings conducted with a total of 21 disarticulation or hemipelvectomy patients are reported. During ambulation the pelvis position in stance phase is controlled and pelvis tilt reduced. The initiation of swing phase is supported. Interaction between hip and knee joint (C-Leg) allows enhanced shock absorption at weight acceptance, causes stance phase flexion and provides for more toe clearance during mid swing phase.

Introduction

The biomechanical principle used to manufacture modern hip disarticulation prostheses was developed over 50 years ago by Mc Laurin [6]. Up to that time, hip joints and some knee joints were locked while walking and unlocked in order to sit down. Locking the joint while walking was required since the hip joint was positioned and attached to the side of or directly underneath the pelvic socket. This placement resulted in prosthesis instability when walking with the joint unlocked.

Based on the concept of the Canadian hip disarticulation prosthesis developed by Mc Laurin, the rotation axis of a monocentric hip joint is positioned anterior and distally at an angle of 45 degrees related to the sagittal position of the natural hip joint. The knee joint is positioned posterior to the alignment reference line (Figure 1). This allows the user to walk with free-moving, unlocked hip and knee joints. Technical implementations found among modular components include both monocentric and polycentric hip joint designs [3]. All currently known joints only execute movements in a single plane.

This means that the natural simultaneous movement of hip flexion / extension and pelvic rotation is not reproduced. The joints also have manual lockin mechanisms or spring-driven extension mechanisms as well as extension stops.

As a result, the contribution made by the musculature towards the reliable functionality of the knee joint when using a pelvic socket prosthesis is immaterial. The degree of security while standing and walking with the pelvic socket prostheses

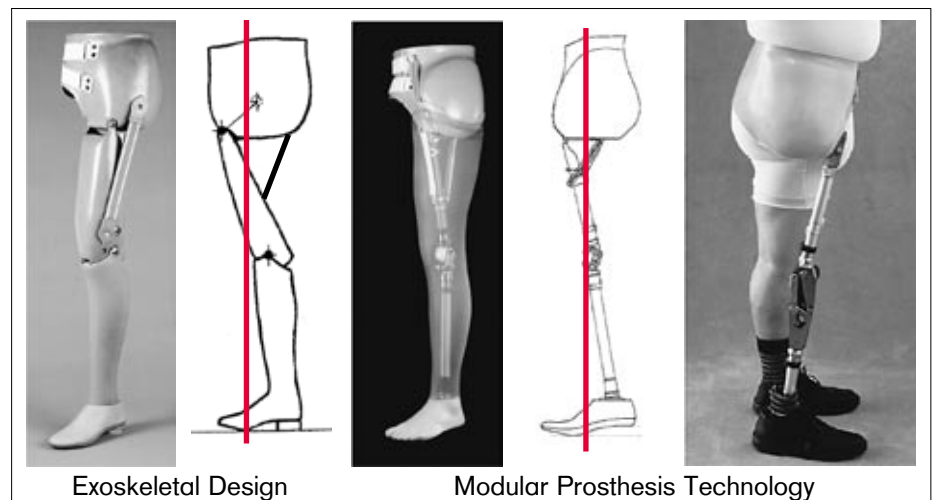

Figure 1 Underlying biomechanical principle of the hip disarticulation prosthesis according to Mc Laurin (1954). Exoskeletal design on the left, modular prosthesis with image of fitting on the right (7E7 hip joint, 3R60 knee joint, Otto Bock HealthCare).

Swing phase initialisation is not supported by currently known designs. Pneumatic or hydraulic controls for the stance and swing phase, which have long become standard in knee joints, have not been implemented in hip joints to date.

Walking with a hip disarticulation prosthesis

As the amputation height increases, the ability of the amputee to affect prosthesis movement using his or her musculature is reduced. Movements of the amputated side become increasingly mechanical and not determined by the musculature as the amputation level moves up. A pelvic socket prosthesis is only controlled by the abdominal and back muscles [4].

is largely determined by the prosthetic alignment and the knee joint mechanism used [2]. In addition to controlling the prosthesis as directly as possible, a properly-fitting pelvic socket should also provide the amputee with feedback regarding prosthesis movements as well as ground characteristics [5].

The gait pattern of a hip disarticulation patient with a Canadian hip disarticulation prosthesis has been described several times [7, 8]. During heel contact at the beginning of the stance phase, the hip joint is flexed. As a result of lower resistance, conventional joints are quickly extended during weight bearing and frequently reach the extension stop as

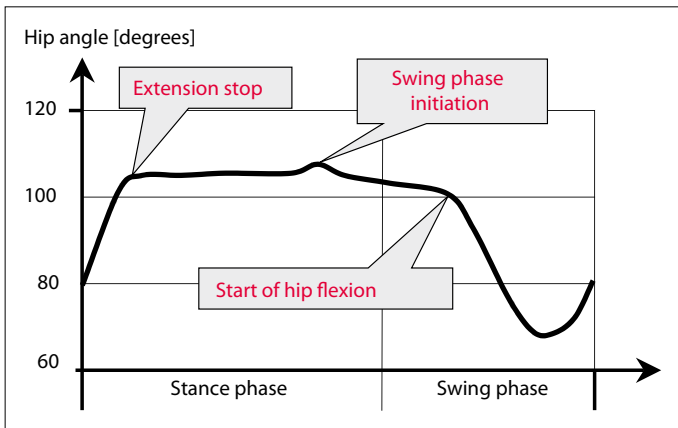

Figure 2 Hip angle with the 7E7 hip joint.

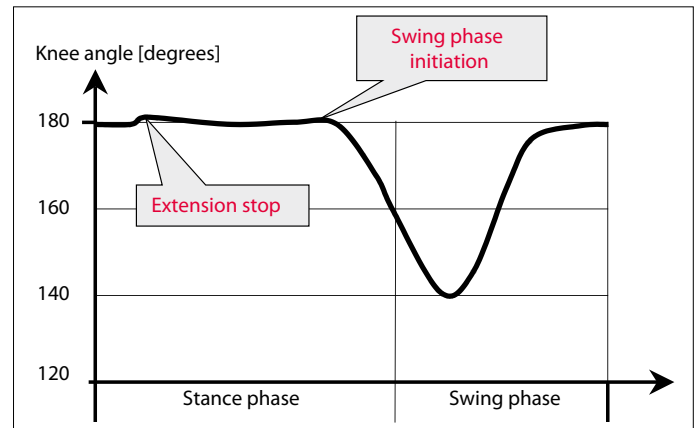

Figure 3 Knee angle with the C-Leg and 7E7 hip joint.

early as the beginning of the single-leg support phase. The knee joint is extended at that time. Once the contralateral leg makes contact with the ground after swinging forward, the swing phase is initiated by tilting the pelvis back. Now the amputee has to achieve sufficient ground clearance through plantar flexion of the sound foot or by pulling up the pelvis on the amputated side while keeping the upper body as upright as possible so that the prosthesis can swing forward freely. At the end of the swing phase, the pendulum movement of the prosthetic limb is slowed down by extension assists. These are individually adjustable and also affect the maximum step length.

Kinematic measurements by Berghof [1] on five patients noted significant individual gait pattern variations. However, he observed a significant amount of pelvic tilt among all of the patients; this effect was reduced among patients that used a walking aid compared to patients that moved freely. In the first half of the stance phase, the pelvic socket is usually quickly tilted dorsally and then ventrally before reaching the extension stop. Due to the excessive ventral tilt and lordosis observed in the second half of the stance phase, the swing phase is initiated relatively late through dorsal rotation of the pelvis.

The typical sagittal movement made by amputees with a hip disarticulation prosthesis is illustrated in Figure 2 and 3. The hip joint extension stop is reached after only 10 to 15 percent of the gait cycle. Even after the active initiation of the swing phase by tilting the pelvis back, the hip joint remains at the extension stop for an extended period of time. The hip joint does not flex until after the extension of the knee joint in the swing phase begins.

Concept of the Helix^{3D} Hip Joint

A new exoprosthetic hip joint cannot be designed without considering knee joint functionality. The hip and knee joint are also connected by dual-joint muscles in the natural limb; the two joints are interdependent.

Figure 4 shows the new hip joint. The joint consists of a so-called spatial four-axis mechanism with hydraulic stance and swing phase control. This novel patented design (inventor: H. Boiten) results in the following biomechanical improvements for the prosthesis wearer compared to conventional joints:



Figure 4 Helix^{3D} hip joint.

- less sudden pelvic movements during weight transfer
- Support for swing phase initiation
- Control of hip movements during the swing phase
- Three-dimensional movements in terms of the relationship between hip joint extension / flexion and transversal pelvic rotation

The axis geometry is based on a so-called R-S-S-R mechanism. This mechanism makes it possible to link hip flexion and extension to hip joint rotation. The rotation angle (transversal movement) depends on the flexion angle (sagittal movement). This dependency is non-linear so that for example a physiological geometry is achieved while sitting so that a normal, unobtrusive sitting position can be achieved. Approximately 6 degrees of rotation should be expected when walking.

The four-axis polycentric structure of the described hip joint consists of two ball joints and two single-axis connections, with the rear axis tilted in relation to the structure. Ball joints form the two anterior connections (Figure 4 and 5).

Specialised hydraulics control the level of stance and swing phase resistance in this hip joint (Figure 6). The hydraulics offer a total of three adjustable parameters:

- Stance phase resistance (ST)
- Free swing range (FSW)
- Swing phase resistance (SW)

At the beginning of the stance phase, the joint features adjustable stance phase resistance (ST) so that the amputee for the first time receives prolonged support during the extension movement.

Swing phase initiation is supported by two flexible polyurethane springs. The integrated PU elements are stretched during stance phase extension in order to store energy. At the beginning of the swing phase, this energy is released and used to accelerate the pendulum movement of the prosthesis. A flexion range with the minimum possible amount of resistance (FSW range) that starts at the extension position can also be set using the hydraulics. Once the end of the free swing range established in this manner is reached while flexing the hip joint, the resistance increases.

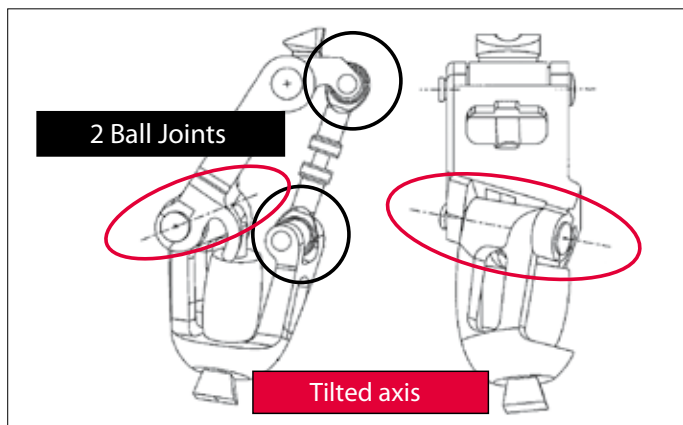

Figure 5 Principle of the spatial four-axis mechanism. An axis tilted in relation to the primary movement plane, an axis vertical to the primary movement plane, two ball joints.

Swing phase resistance (SW) becomes effective. Both adjustments, FSW and SW, are primarily used to adjust the step length. As the walking speed changes, hydraulic resistance adjusts correspondingly similar to Hydraulic swing phase controls in conventional knee joints.

Initial Results and Experiences with the Hip Joint

Experiences and initial results for the described hip joint are available in the form of scientific studies [5] and trial or test fittings for 18 hip disarticulation amputees and three hemipelvectomy amputees.

Movement characteristics typical for conventional hip joints change significantly in the primary movement plane (sagittal plane). Note that both the hip joint and the knee joint (C-Leg) are in motion during most of the gait cycle (Figure 7 and 8).

Hip joint extension from the beginning of the stance phase until the extension stop is reached takes longer than just 15 percent of the gait cycle (see Figure 2). Pelvic tilt is reduced by approximately six degrees over the gait cycle.

Since the hydraulics dampen extension, the abrupt stop is eliminated. As a result, amputees no longer feel the otherwise pronounced extension stop to which patients become accustomed as they use a prosthesis. Figure 9 illustrates the stance phase resistance adjustment range. The extension stop can be reached at a low resistance very early in the gait cycle, or at very high resistance late in gait cycle.

The ability of this new hip joint function to use stance phase hydraulics in order to provide supporting resistance torque in the stance phase has a significant impact on knee functionality and safety. Knee flexion in the stance phase – at the time of weight transfer immediately after heel contact – is observed among all amputees with an optimal prosthetic alignment. This is the result of leverage changes in the knee joint. The vertical distance between the ground reaction force line of action and the knee joint axis is shifted posterior by approximately 25 mm when the described hip joint is used instead

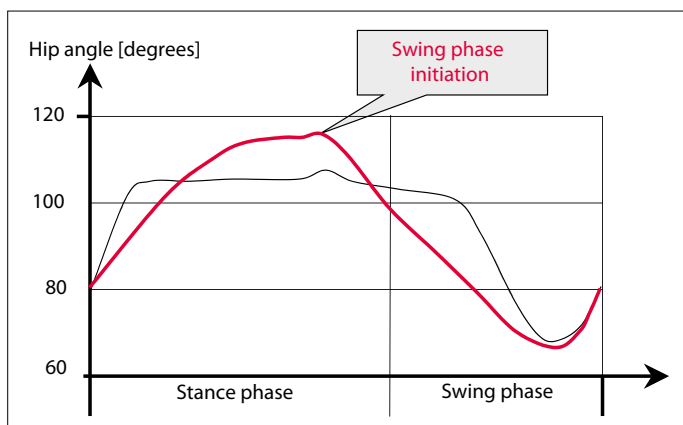

Figure 7 Hip angle gradient during the gait cycle with the 7E7 (black) and Helix^{3D} (red) hip joints.

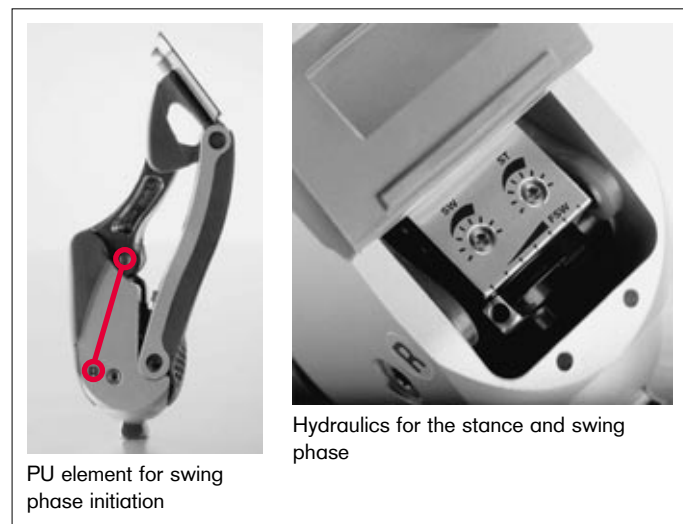

Figure 6 Stance and swing-through phase control of the hip joint described in the article. Hydraulics for stance (ST) and swing-through phase resistance (FSW, SW), polyurethane elements (PU) to support swing-through phase initialisation.

of a conventional hip joint such as the 7E7. This combination of hip and knee joint movement facilitates good shock absorption that can be perceived by the amputee.

The PU elements help the amputee initiate the swing phase. They cause the hip joint to begin flexing immediately after the initiation of the swing phase. As a result, the hip joint does not remain at the extension stop until after knee extension is initiated, as it does with a conventional fitting. Both joints, the hip joint and the knee joint, are simultaneously flexed during the mid swing phase. Combined by the shortening effect of the polycentric hip joint structure, this results in an increase in ground clearance while swinging the prosthesis forward, as noted and described by amputees (Figure 7 and 8). The PU elements also flex the hip when the prosthesis is lifted. This provides good support when the user starts walking with the prosthetic limb from a standing position. However,

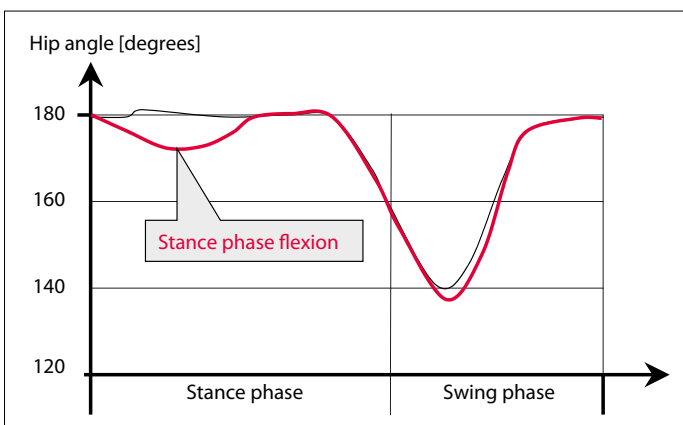

Figure 8 Hip angle gradient during the gait cycle with the 7E7 (black) and Helix^{3D} (red) hip joints and the C-Leg knee joint.

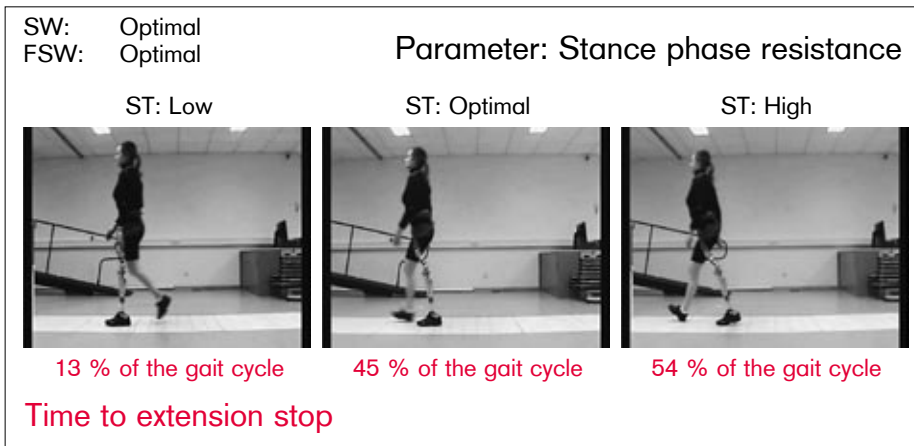

Figure 9 Images to illustrate the stance phase resistance (ST) adjustment range.

the prosthesis becomes unstable when unsuitable knee joints such as polycentric joints are used in combination with the Helix^{3D} hip joint.

Amputees describe the effects of the combined movement (flexion and rotation) during the stance phase while walking slowly as especially advantageous.

With the adjustment parameters SW and FSW, both the step length and adequate terminal damping can be readily adjusted to the needs of individual patients. Figure 10 provides an impression of the step length adjustment range that can be achieved with the swing phase resistance adjustment parameter – 13 cm in this case. Combined with the free swing range, adjustments from very short to very long steps are possible.

The principles for the hip disarticulation prostheses developed by Mc Laurin have once again proven itself for the new hip joint. In addition to a well-fitting pelvic socket, the alignment of the prosthesis is crucial for optimum fitting quality. The combination of the described hip joint with the C-Leg as part of a pelvic socket prosthesis provides amputees with high amputation levels functionality and security.

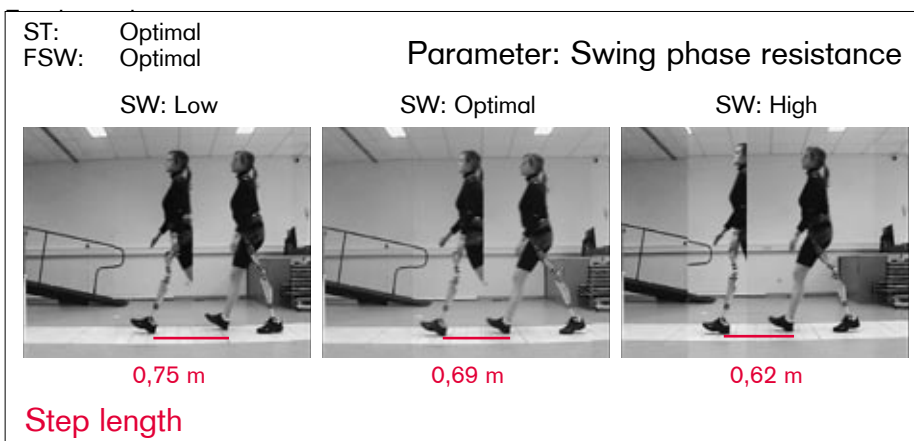

Figure 10 Changes in the step length by adjusting swing phase resistance (SW).

Literature:

- [1] Berghof, R.: Kinematische Ganganalyse von Patienten mit Hüftexartikulationsprothesen (Kinematic Gait Analysis in Patients with Hip Disarticulation Prostheses). Orthopädie-Technik 46 (1995), 762-767
- [2] Blumentritt, S.: Biomechanische Aspekte zur Indikation von Prothesenkniegelenken (Biomechanical Aspects for the Indications of Prosthetic Knee Joints). Orthopädie-Technik 55 (2004), 508-521
- [3] Greitemann, B., H. Bork, L. Brückner: Rehabilitation Amputierter (The Rehabilitation of Amputees). Stuttgart, Gentner Verlag, 2002
- [4] Hauser, D.: Tuberumgreifende Einbettung bei Hüftexartikulations-Prothesen (Hip Disarticulation Prostheses – Embedding Encompassing the Ischial Tuberosity). Orthopädie-Technik 56 (2005), 408-411
- [5] Ludwigs, E.: Untersuchungen zur Biomechanik eines neuen exoprothetischen Hüftgelenkkonzeptes (Investigation of the Biomechanics of a new Exoprosthetic Hip Joint Concept). Diploma thesis, Münster University of Applied Sciences - Steinfurt, 2007
- [6] Mc Laurin, C. A.: Hip disarticulation prosthesis. Report 15, Prosthetic Services Centre, Department of Veterans Affairs, Toronto, 1954
- [7] Mc Laurin, C. A.: The Canadian hip disarticulation prosthesis. Prosthetic and Orthotic Practice. Publisher G. Murdoch, Edward Arnold, London (1969), 285-304
- [8] Radcliffe, C. W.: The biomechanics of the Canadian-type hip disarticulation prosthesis; Artificial Limbs. 4 (1957), 29-38

With compliments from *Otto Bock*[®]